

**Ventilating Filters - Vandalism Proof****LE.0716 · LE.0817 · LE.0827 · LE.0818 · LE.0819**

With filling filter · 6 hole flange · Nominal flow rate up to 850 l/min / 225 gpm

Ventilating Filter  
LE.0817**Description****Application**

Filling / ventilation of tanks for hydraulic and lubrication systems as well as gearboxes.

**General**

The oil levels in the tanks of hydraulic systems are subject to continuous variation due to temperature changes and the operation of cylinders and pressure vessels. In order to prevent over pressure in the tanks, an exchange of air with the external atmosphere is necessary. By the use of a ventilating filter, the outside air that is drawn in is filtered and ingress of dust is therefore prevented. A combined filling filter prevents coarse impurities from entering during filling or re-filling due to maintenance or repair reasons.

**Special features**

The profiled metal flange with elastomer sealing and the mounting with 6 screws ensure that the filling / ventilating filters seal reliable even on non-planar tank surfaces. Filler screens made of sturdy expanded metal offer 100% safety during filling of the tank – which excludes any damage being caused for example by the filler neck. The ventilating filter is fixed by a chain at the filling filter to prevent it from being lost (exception: LE.0716).

The ventilation openings of the ventilating filters are designed that dust on the surface of the tank is not drawn in, and that the ingress of spray and rainwater is largely prevented.

The patented vandalism proof ventilating filters can only be removed with the special tool supplied. This makes the misuse of the ventilating filter or the ingress of dirt via the tank port considerably more difficult.

**Design***Filling filter:*

Cylinder screen - flow direction from center to outside.

*Ventilating filter:*

Flow direction bi-directional (air IN/OUT).

The star-shaped pleating of the filter material results in:

- › large filter surfaces
- › low pressure drop
- › high dirt-holding capacities
- › long service life

## Ordering options / versions

### *Integrated oil-level dipstick*

A dipstick can be integrated in the ventilating filter for checking the oil level. Therefore, a separate dipstick or an additional opening in the tank is not required.

### *Double check valve in the ventilating filter:*

By the use of double check valves, the exchange of air between the tank and the environment is considerably reduced, whereby the ingress of dust is minimized and the lifetime of the ventilating filter is increased.

With the double check valve, an over-pressure is created in the tank in order to improve the suction conditions for the pumps. A further advantage is the reduction of spray water ingress and the loss of oil through the ventilating filter.

### *Vandalism proof version "Standard" (LE.0818):*

Ventilating filters in the patented vandalism proof version can only be removed with the special spanner supplied (AF 47).

This makes the misuse of the ventilating filter or the ingress of dirt via the tank port considerably more difficult.

### *Vandalism proof version "Easy Lock" (L1.0819):*

Ventilating filters in the patented "Easy Lock" version can only be removed with the special pin supplied.

## Maintenance

Ventilating filters should be changed at least every 1000 operating hours, or at minimum once a year.

## Characteristics

### Nominal flow rate

Filling filter: up to 200 l/min / 52.8 gpm  
Ventilating filter: up to 850 l/min / 225 gpm  
(see Selection Chart, column 2).

The nominal flow rates indicated by ARGO-HYTOS are based on the following criteria:

- › Ventilating filters without double check valve:  
 $\Delta p \leq 0.03 \text{ bar} / \Delta p \leq 0.44 \text{ psi}$  for air IN
- › Ventilating filters with double check valve:  
 $\Delta p \leq 0.1 \text{ bar} / \Delta p \leq 1.45 \text{ psi}$  for air IN

### Connection

Filling filter: 6 hole flange, hole pattern according to DIN 24557/T2.

Ventilating filter: outer thread M42 x 2  
(the thread dimensions do not exactly conform to the ISO standard thread / functioning with the ISO standard thread is guaranteed).

### Mounting / sealing

#### *Version without double check valve:*

6 self-tapping screws ISO 1479-ST4,8x16-C with washers.

#### *Version with double check valve:*

6 Philips head screws ISO 7045 M5x16-4.8-Z with O-rings.

Sealing of flange with elastomer gasket  
(mounting accessories and gaskets included in basic equipment).

### Filter fineness

Filling filter: 800  $\mu\text{m}$   
Ventilating filter: 2  $\mu\text{m}$ , tested in a single pass test with ISO MTD.

### Hydraulic fluids

Mineral oil and biodegradable fluids  
(HEES and HETG, see info sheet 00.20).

### Temperature range hydraulic fluid

-30 °C ... +100 °C (temporary -40 °C ... +120 °C)  
-22 °F ... +212 °F (temporary -40 °F ... +248 °F)

### Temperature range environment

-30 °C ... +100 °C  
-22 °F ... +212 °F

### Materials

Cap: Polyamide, GF reinforced  
Base: Polyamide, GF reinforced  
Filler screen: Steel, galvanized  
Spanner: Steel, galvanized  
Gaskets: NBR (FPM on request)  
Filter media: Composite, multi-layer

### Mounting position

No limitation, position on the tank see section Layout.

**Δp-curves for complete filters in Selection Chart, column 2**

**D1** Pressure drop as a function of the **flow volume**  
**Air IN/OUT**

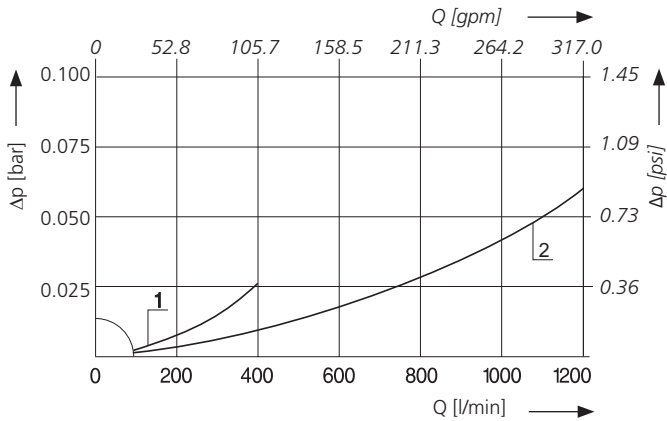

**D2** Pressure drop as a function of the **flow volume**  
**Air IN**

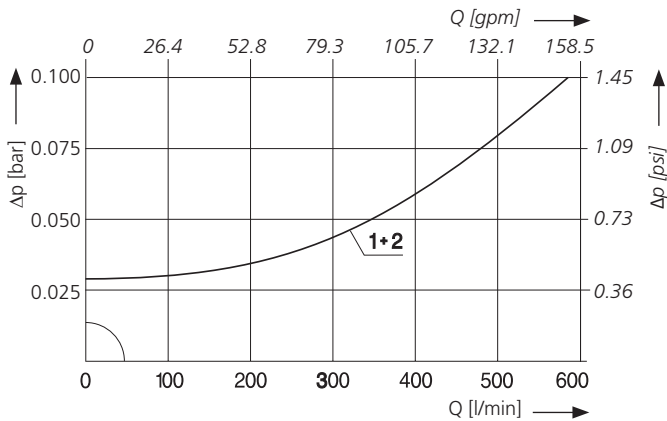

Pressure drop as a function of the **flow volume**  
**Air OUT**

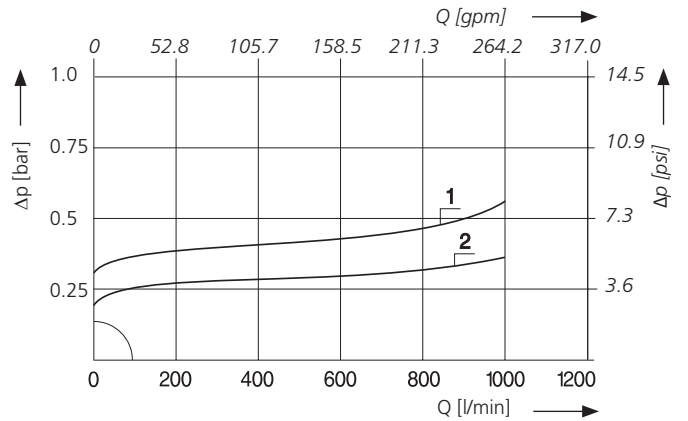

**Filter fineness curves in Selection Chart, column 5**

**Dx** Filtration ratio  $\beta$  as a function of particle size  $x$  tested in a single pass test with ISO MTD

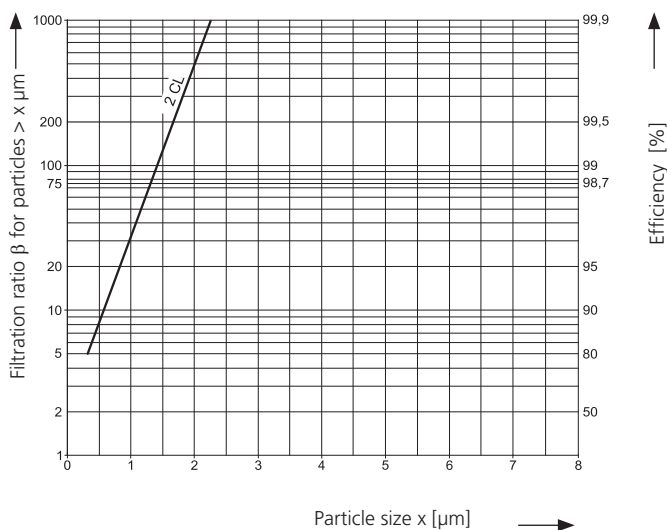

The abbreviation represents the following  $\beta$ -values resp. finenesses:

**2CL**

- › 2  $\mu$ m Composite  
99.5% efficiency for particles of size 2  $\mu$ m tested in a single pass test with ISO MTD.

For special applications, finenesses differing from these curves are also available by using special composed filter media.

## Selection Chart

Part No.	Pressure drop see diagram <b>D1</b> /curve no.	Nominal flow rate filling filter	Nominal flow rate ventilating filter	Filter fineness	Filter fineness vent. filter	Filter surface vent. filter	Filter fineness filling filter	Filter surface filling filter	DCV <sup>6</sup> -cracking pressure air IN	DCV <sup>6</sup> -cracking pressure air OUT	Spare ventilating filter	Symbol	Weight	Remarks
1	2	l/min	l/min		cm <sup>2</sup>	µm	cm <sup>2</sup>	bar	bar		11	12	13	14
<b>LE.0716-02<sup>1</sup></b>	<b>D1/1</b>	110 <sup>2</sup>	250	2CL	50	800	160	-	-	L1.0706-02	1	255	without chain <sup>4</sup>	
<b>LE.0817-01<sup>1</sup></b>	<b>D1/2</b>	110 <sup>2</sup>	850	2CL	203	800	160	-	-	L1.0807-31	1	350	-	
LE.0817-91	<b>D2/2</b>	110 <sup>2</sup>	550 <sup>3</sup>	2CL	203	800	160	-0.03	0.20	L1.0807-91	2	370	-	
<b>LE.0817-51<sup>1</sup></b>	<b>D2/1</b>	110 <sup>2</sup>	550 <sup>3</sup>	2CL	203	800	160	-0.03	0.35	L1.0807-51	2	370	-	
LE.0827-01	<b>D1/2</b>	200 <sup>2</sup>	850	2CL	203	800	285	-	-	L1.0807-31	1	400	-	
LE.0827-91	<b>D2/2</b>	200 <sup>2</sup>	550 <sup>3</sup>	2CL	203	800	285	-0.03	0.20	L1.0807-91	2	420	-	
LE.0827-51	<b>D2/1</b>	200 <sup>2</sup>	550 <sup>3</sup>	2CL	203	800	285	-0.03	0.35	L1.0807-51	2	420	-	
LE.0818-01 <sup>5</sup>	<b>D1/2</b>	110 <sup>2</sup>	850	2CL	203	800	160	-	-	L1.0808-00	1	350	with spanner AF 47	
LE.0818-53 <sup>5</sup>	<b>D2/2</b>	110 <sup>2</sup>	550 <sup>3</sup>	2CL	203	800	160	-0.03	0.20	L1.0808-53	2	370	with spanner AF 47	
LE.0818-51 <sup>5</sup>	<b>D2/1</b>	110 <sup>2</sup>	550 <sup>3</sup>	2CL	203	800	160	-0.03	0.35	L1.0808-52	2	370	with spanner AF 47	
LE.0819-01 <sup>5</sup>	<b>D1/2</b>	110 <sup>2</sup>	850	2CL	203	800	160	-	-	L1.0809-01	1	350	with Easy Lock Pin	
LE.0819-54 <sup>5</sup>	<b>D2/2</b>	110 <sup>2</sup>	550 <sup>3</sup>	2CL	203	800	160	-0.03	0.20	L1.0809-54	2	370	with Easy Lock Pin	
LE.0819-55 <sup>5</sup>	<b>D2/1</b>	110 <sup>2</sup>	550 <sup>3</sup>	2CL	203	800	160	-0.03	0.35	L1.0809-55	2	370	with Easy Lock Pin	

<sup>1</sup> Preferred type, no minimum order quantity required

<sup>2</sup> At 200 mm<sup>2</sup>/s (ISO VG 46 at approx. 15°C)

<sup>3</sup> Δp ≤ 0.1 bar for air IN

<sup>4</sup> Ventilating filter not fixed by a chain at the filling filter

<sup>5</sup> Vandalism proof

<sup>6</sup> Double check valve

### Remark:

The ventilating filters listed in this chart are standard filters. If modifications are required, e.g. with integrated dipstick, we kindly ask for your inquiry.

## Selection Chart

Part No.	Pressure drop see diagram <b>D</b> /Curve no.	Nominal flow rate filling filter	Nominal flow rate ventilating filter	Filter fineness	Filter surface vent. filter	Filter fineness filling filter	Filter surface vent. filter	DCV <sup>5</sup> -cracking pressure air IN	DCV <sup>5</sup> -cracking pressure air OUT	Spare ventilating filter	Symbol	Weight	Remarks
1	2	gpm	gpm		inch <sup>2</sup>	µm	inch <sup>2</sup>	psi	psi			lbs	14
LE.0716-02	<b>D1/1</b>	29 <sup>1</sup>	66	2CL	7.8	800	24.8	-	-	L1.0706-02	1	0.56	without chain <sup>3</sup>
LE.0817-01	<b>D1/2</b>	29 <sup>1</sup>	225	2CL	31.5	800	24.8	-	-	L1.0807-31	1	0.77	-
LE.0817-91	<b>D2/2</b>	29 <sup>1</sup>	145 <sup>2</sup>	2CL	31.5	800	24.8	-0.44	2.90	L1.0807-91	2	0.82	-
LE.0817-51	<b>D2/1</b>	29 <sup>1</sup>	145 <sup>2</sup>	2CL	31.5	800	24.8	-0.44	5.08	L1.0807-51	2	0.82	-
LE.0827-01	<b>D1/2</b>	52 <sup>1</sup>	225	2CL	31.5	800	44.2	-	-	L1.0807-31	1	0.88	-
LE.0827-91	<b>D2/2</b>	52 <sup>1</sup>	145 <sup>2</sup>	2CL	31.5	800	44.2	-0.44	2.90	L1.0807-91	2	0.93	-
LE.0827-51	<b>D2/1</b>	52 <sup>1</sup>	145 <sup>2</sup>	2CL	31.5	800	44.2	-0.44	5.08	L1.0807-51	2	0.93	-
LE.0818-01 <sup>4</sup>	<b>D1/2</b>	29 <sup>1</sup>	225	2CL	31.5	800	24.8	-	-	L1.0808-00	1	0.77	with spanner AF 47
LE.0818-53 <sup>4</sup>	<b>D2/2</b>	29 <sup>1</sup>	145 <sup>2</sup>	2CL	31.5	800	24.8	-0.44	2.90	L1.0808-53	2	0.82	with spanner AF 47
LE.0818-51 <sup>4</sup>	<b>D2/1</b>	29 <sup>1</sup>	145 <sup>2</sup>	2CL	31.5	800	24.8	-0.44	5.08	L1.0808-52	2	0.82	with spanner AF 47
LE.0819-01 <sup>4</sup>	<b>D1/2</b>	29 <sup>1</sup>	225	2CL	31.5	800	24.8	-	-	L1.0809-01	1	0.77	with Easy Lock Pin
LE.0819-54 <sup>4</sup>	<b>D2/2</b>	29 <sup>1</sup>	145 <sup>2</sup>	2CL	31.5	800	24.8	-0.44	2.90	L1.0809-54	2	0.82	with Easy Lock Pin
LE.0819-55 <sup>4</sup>	<b>D2/1</b>	29 <sup>1</sup>	145 <sup>2</sup>	2CL	31.5	800	24.8	-0.44	5.08	L1.0809-55	2	0.82	with Easy Lock Pin

<sup>1</sup> At 930 SUS (ISO VG 46 at approx. 59°F)

<sup>2</sup>  $\Delta p \leq 1.45$  psi for air IN

<sup>3</sup> Ventilating filter not fixed by a chain at the filling filter

<sup>4</sup> Vandalism proof

<sup>5</sup> Double check valve

### Remark:

The ventilating filters listed in this chart are standard filters. If modifications are required, e.g. with integrated dipstick, we kindly ask for your inquiry.

## Dimensions

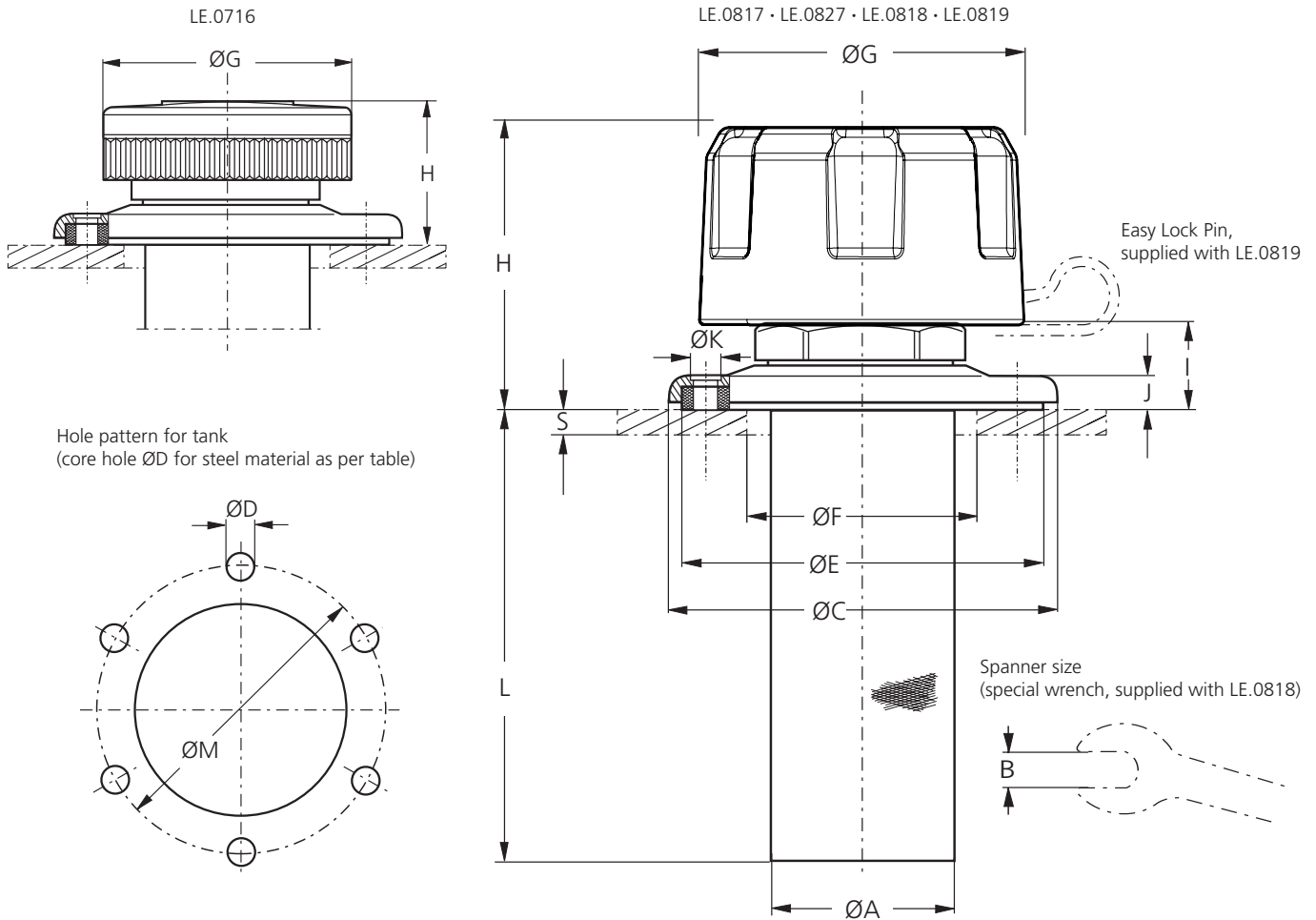

## Measurements in mm

Type	A	B	C	E	F	G	H	I	J	K	L	M
LE.0716	46	-	89.5	84.5	58	66	36	15	6	5.6 ± 0.3	111	73
LE.0817	46	AF 47	89.5	84.5	58	80	61	20	6	5.6 ± 0.3	111	73
LE.0827	46	AF 47	89.5	84.5	58	80	61	20	6	5.6 ± 0.3	200	73
LE.0818	46	AF 47	89.5	84.5	58	80	61	20	6	5.6 ± 0.3	111	73
LE.0819	46	AF 47	89.5	84.5	58	80	61	20	6	5.6 ± 0.3	111	73

Plate thickness S over / up to	Hole D*
1.00 / 1.75	3.9
1.75 / 3.00	4.1
3.00 / 4.75	4.4
4.75	M5

## Measurements in inch

Type	A	B mm	C	E	F	G	H	I	J	K	L	M
LE.0716	1.81	-	3.52	3.33	2.28	2.60	1.42	0.59	0.24	0.22±0.01	4.37	2.87
LE.0817	1.81	AF 47	3.52	3.33	2.28	3.15	2.40	0.79	0.24	0.22±0.01	4.37	2.87
LE.0827	1.81	AF 47	3.52	3.33	2.28	3.15	2.40	0.79	0.24	0.22±0.01	7.87	2.87
LE.0818	1.81	AF 47	3.52	3.33	2.28	3.15	2.40	0.79	0.24	0.22±0.01	4.37	2.87
LE.0819	1.81	AF 47	3.52	3.33	2.28	3.15	2.40	0.79	0.24	0.22±0.01	4.37	2.87

Plate thickness S over / up to	Hole D*
0.04 / 0.07	0.15
0.07 / 0.12	0.14
0.12 / 0.19	0.17
0.19	M5

\* Core hole Ø D for self-tapping screws according to DIN 7975 for versions without double check valve.  
For versions with double check valve always use M5. Fastening screws included in basic equipment.

## Symbols

1

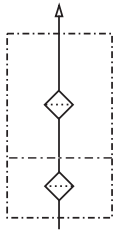

2

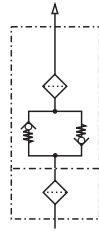

## Layout

### Sizes

The determining factor for selecting the size is the maximum over / under pressure allowed in the tank.

For versions without double check valves, the initial pressure drop with a clean air filter should not exceed 0.03 bar / 0.44 psi.  
For versions with double check valves, the initial pressure drop for air IN with a clean air filter should not exceed 0.1 bar / 1.45 psi.

### Filter fineness

In the ideal case, the fineness of the ventilating filter matches the fineness of the system filter (see also CETOP RP 98 H).  
By the use of filter fineness 2 CL the ingress of dust into the tank is effectively reduced.

### Mounting

The ventilating filter should be mounted in a low-dust area of the machine and not in depressions in which water can collect.  
For mobile use, the ventilating filter is to be mounted on the tank such that neither splashing oil from the inside nor spray water from the outside can reach the area of the ventilation opening.

### Double check valves

By the use of double check valves, the exchange of air between the tank and the environment can considerably be reduced, whereby the ingress of dust is minimized and the lifetime of the ventilating filter is increased.

With the double check valve, a predefined level of pressure can be created in the tank in order to improve the suction conditions for the pumps.

The valve opening pressure required for the ventilating filter can be approximately determined with the ideal gas equation depending on the following system characteristics:

- › differential volume
- › volume of oil in the system
- › volume of air in the tank
- › operating temperatures

Calculation tool available.

## Quality Assurance

### Quality management according to DIN EN ISO 9001

To ensure constant quality in production and operation, ARGO-HYTOS filter elements undergo strict controls and tests according to the following ISO standards:

ISO 2941	Verification of collapse / burst pressure rating
ISO 2942	Verification of fabrication integrity (Bubble Point Test)
ISO 2943	Verification of material compatibility with fluids
ISO 3968	Evaluation of pressure drop versus flow characteristics
ISO 16889	Multi-Pass-Test (evaluation of filter fineness and dirt-holding capacity)
ISO 23181	Determination of resistance to flow fatigue using high viscosity fluid

**Various quality controls during the production process guarantee the leakfree function and solidity of our filters.**

Illustrations may sometimes differ from the original. ARGO-HYTOS is not responsible for any unintentional mistake in this specification sheet.